

# LAWN-BOY®

## GOLD-SERIES WALK-BEHIND POWER MOWER

MODEL 10415 - 3900001 & UP

MODEL 10515 - 3900001 & UP

---

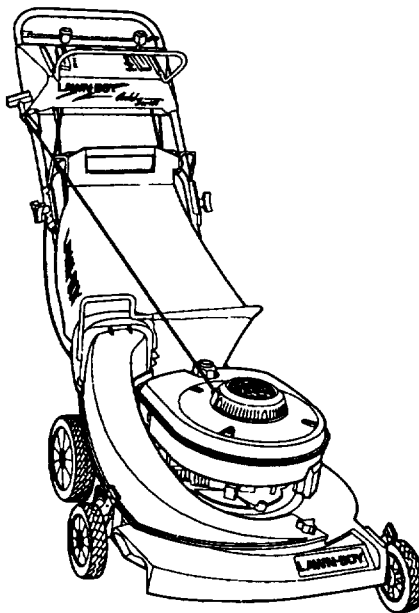

---

## OPERATOR'S MANUAL

**IMPORTANT:** This Operator's Manual contains information regarding your personal safety. Read it carefully. Become familiar with the controls and proper use of the mower before attempting to use it.

# TABLE OF CONTENTS

<b>SAFETY INSTRUCTIONS</b> ..... a - b	Clean Mower Housing ..... 4.3
<b>1 ASSEMBLY</b> ..... 1.1	Blade ..... 4.3-4.4
Handle ..... 1.1	Lubrication ..... 4.5
Cover Plate ..... 1.1	Self-Propelled Cable ..... 4.5
<b>2 BEFORE STARTING</b> ..... 2.1	Exhaust Ports ..... 4.6-4.7
Oil Mix Ratio ..... 2.1	<b>5 TROUBLESHOOTING</b> ..... 5.1
Mixing Gasoline and Oil ..... 2.1-2.2	<b>6 ACCESSORIES</b> ..... 6.1
Lawn Preparation & Mowing ..... 2.2	Rear Grass Catcher ..... 6.1-6.2
<b>3 OPERATION</b> ..... 3.1	Power Mulch™ Plate ..... 6.3
Starting Engine ..... 3.1	<b>7 STORAGE</b> ..... 7.1
Stopping Engine ..... 3.1	Fuel ..... 7.1
Adjusting Cutting Height ..... 3.2	Engine ..... 7.1
Self-Propelled Drive ..... 3.2	Folding Handle ..... 7.2
<b>4 MAINTENANCE</b> ..... 4.1	Removing from Storage ..... 7.2
Recommended Maintenance	<b>8 MAINTENANCE RECORD</b> ..... 8.1
Schedule ..... 4.1	<b>WARRANTY</b> ..... Back Cover
Air Filter ..... 4.1-4.2	
Spark Plug ..... 4.2	

## PRODUCT IDENTIFICATION

A model and serial number decal is located on back of control panel; record for future reference. Use this model number and serial number when ordering parts or in correspondence.

**Model Number:** \_\_\_\_\_ **Serial Number:** \_\_\_\_\_

This mower is designed for cutting and mulching grass or, when equipped with a grass bag, for catching cut grass. Any use for purposes other than these could prove dangerous to user or bystanders.

### **WARNING**

- This product emits carbon monoxide during operation which is a chemical known to the state of California to cause birth defects.

**NOTE:** This symbol advises you of information important to the operation or maintenance of your equipment.

**NOTE:** This engine is NOT equipped with a spark arrester muffler. Use or operation of this mower in the State of California on any forest covered, brush-covered or unimproved grass covered land, without an approved spark arrester muffler, is a violation of the law. Other states may have similar laws.

# SAFETY INSTRUCTIONS

This mower meets or exceeds CPSC blade safety requirements for walk-behind rotary mowers and the B71.1 specifications of the American National Standards Institute, in effect at time of production. However, improper use or maintenance by the operator or owner can result in injury. To reduce the potential for injury, comply with these safety instructions and always pay attention to the safety alert  symbol which means CAUTION, WARNING or DANGER - "personal safety instruction." Failure to comply with the instruction may result in personal injury.

## BEFORE OPERATING

1. Read this manual carefully before operating the mower. Become familiar with the controls and proper use of the mower. Never allow children to operate the mower or adults to operate it without proper instructions.
2. Keep everyone, especially children and pets, away from area of operation. Thoroughly inspect area where mower will be used and remove sticks, stones, wire, and debris.
3. Wear long pants and substantial shoes. Do not operate mower while wearing open sandals or when barefoot.
4. Check fuel level before starting engine. Do not fill fuel tank indoors, when the engine is running, or until engine cools for several minutes after running. Wipe up spilled gasoline before starting engine.
5. Keep all guards, shields, grass catchers and safety devices in place. Repair or replace damaged parts, including decals.
6. Self-propelled drive and blade are designed to stop when control bails are released. Ensure control and brake function properly before each use of mower.
9. Mow across the face of slopes; never up and down. Use extreme caution when changing direction on slopes. Do not mow excessively steep slopes.
10. Always wear safety glasses or eye shields during operation to protect eyes from foreign objects that may be thrown from the machine. Keep face, hands, and feet away from the mower housing and cutter blade when the engine is running. Stay behind the handle until the engine stops.
11. Since the blade rotates for a few seconds after the blade control bail is released, stay behind the handle until all movement stops.
12. After striking a foreign object or if mower vibrates abnormally, stop engine and remove wire from spark plug. Check mower for damage and make all repairs before using mower again.
13. Stop the engine before adjusting the height-of-cut.
14. Stop the blade/engine when crossing a gravel driveway, road, or sidewalk.
15. Stop engine before leaving the operator's position - behind the handle. Disconnect wire from spark plug if mower will be unattended.

## WHILE OPERATING

7. Do not run engine indoors.
8. Always maintain secure footing. Keep a firm grip on the handle and walk; never run. Never operate mower in wet grass. Mow only in daylight or in good artificial light.
16. Do not touch engine while it is running or shortly after it is stopped because engine will be hot enough to cause a burn.

## **MAINTENANCE**

17. Perform only those maintenance instructions described in this manual. If major repairs are ever needed or if assistance is desired, contact your local Authorized Lawn-Boy Service Dealer.

18. Before mower is cleaned, inspected, serviced, or adjusted, stop engine and disconnect wire from spark plug. Keep wire away from plug to prevent accidental starting.

19. To assure the mower is in safe operating condition, frequently check and keep all nuts, bolts, and screws tight. Assure blade nut is tightened to 560 in.-lbs. (47 ft.-lbs.) (63 Nm).

20. To reduce fire hazard, keep engine free of excessive grease, grass, leaves, and accumulations of dirt.

21. Allow engine to cool before storing mower in any enclosure. Do not store mower near any open flame or where gasoline fumes may be ignited by a spark.

22. Do not overspeed the engine by changing governor settings.

23. At the time of manufacture, the mower conformed to the safety standards in effect for rotary mowers. To ensure best performance and continued safety certification of the mower, use genuine Lawn-Boy replacement parts and accessories.

# 1 ASSEMBLY

## HANDLE

**A** Loosen handle knobs and lift top handle half in an arc until handle halves are in line and nest together.

**NOTE:** Use care to prevent pinching or stretching of cables.

Tighten knobs securely.

**B** Handle may be placed in three (3) height positions, high, medium and low. Select a for handle height position that is most comfortable for you.

Align holes in lower handle section with holes in handle bracket. Using hardware shown, secure handle to handle brackets.

**(self-propelled models only)** cable bracket must be secured on left side with handle hardware.

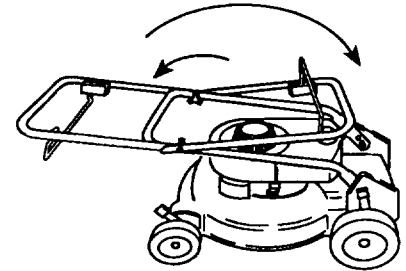

Fig. A

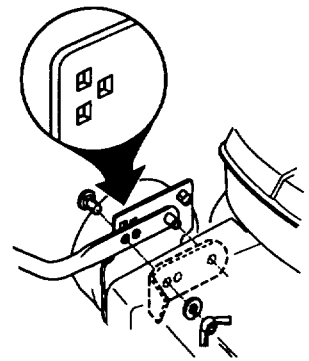

Fig. B

## COVER PLATE

Your mower was shipped with a cover plate. For side discharge operation the plate must be installed into deck opening.

### **⚠ WARNING**

- Thrown objects or blade contact can cause serious injury.
- Never operate mower unless cover plate, mulch plate or grass chute and catcher are installed.

Stop engine and disconnect spark plug wire before installing or removing cover plate.

**C** Remove wing screw that fastens cover plate to the housing.

**D** Two shoulder bolts on the housing protrude through slotted holes in the cover plate and do not have to be loosened or removed. Cover plate moves over the shoulder bolt heads.

Slide cover plate clockwise to install or counter-clockwise to remove.

Secure with wing screw.

Connect spark plug wire.

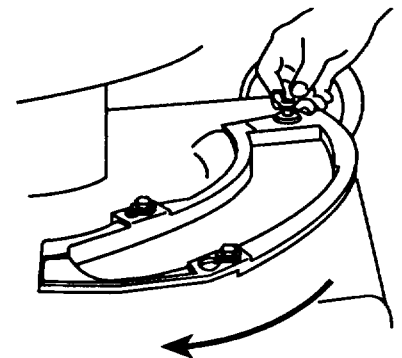

Fig. C

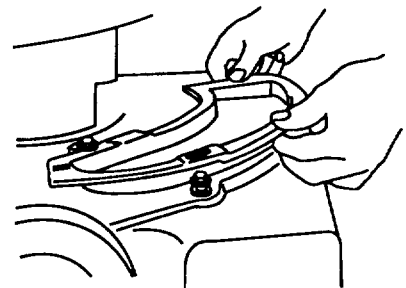

Fig. D

## 2 BEFORE STARTING

### **▲ WARNING**

- Gasoline is extremely flammable, highly explosive and under certain conditions can cause personal injury or property damage.
- Do not smoke or allow an open flame or spark when refueling mower.
- Refuel mower outdoors and only when engine is cold.

### **OIL MIX RATIO**

Your Lawn-Boy mower is powered by a 2-cycle engine which requires a mixture of gasoline and oil **32:1 with Lawn-Boy® 2-CYCLE ASHLESS OIL**. Failure to use the right mixture will result in serious engine damage.

**A** Use Lawn-Boy 2-CYCLE ASHLESS OIL, which is formulated specifically for Lawn-Boy and is available from your Lawn-Boy retailer. Regular use of Lawn-Boy 2-CYCLE ASHLESS OIL will help keep your engine clean, reduce spark plug fouling, piston ring sticking and pre-ignition. Lawn-Boy 2-CYCLE ASHLESS OIL will also minimize varnish build-up, combustion chamber deposits and exhaust port blockage.

If Lawn-Boy 2-CYCLE ASHLESS OIL is not available, other premium grade 2-CYCLE ASHLESS OIL can be substituted. Substitute oils may produce more exhaust smoke and may require increased engine service including more frequent spark plug changes, exhaust port/cylinder decarbonizing and could reduce engine life.

**NOTE:** NEVER USE AUTOMOTIVE OIL ( i.e. SAE 30, 10W30 etc.), OR THE WRONG MIX RATIO BECAUSE ENGINE DAMAGED MAY OCCUR. If engine failure occurs and it has been determined that Lawn-Boy 2-CYCLE ASHLESS OIL was not used, the failure may not be covered by the Lawn-Boy warranty.

### **MIXING GASOLINE AND OIL**

**B** For simplicity and best engine performance, mix 8 oz. of Lawn-Boy 2-CYCLE ASHLESS OIL with two gallons of fresh, unleaded regular gasoline. Pour one gallon of gasoline into an approved gasoline container and add the correct amount of 2-cycle oil. Install cap on gasoline container and shake to mix oil and gasoline thoroughly. Slowly remove cap and add remaining gasoline.

**NOTE:** Do not mix gasoline and oil in the product fuel tank. Oil that is at room temperature mixes easily and more thoroughly than cold oil.

Use clean, fresh lead-free gasoline with an octane rating of 85 or higher. Purchase only the quantity of gasoline that can be used in 30 days to assure freshness. Use of lead-free gasoline

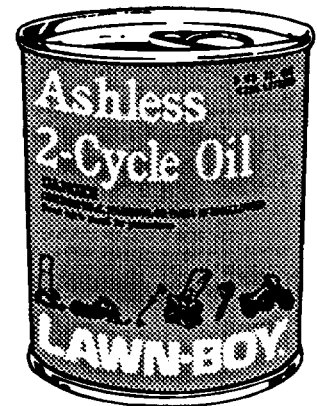

**Fig. A**



**Fig. B**

## **BEFORE STARTING** Continued

results in fewer combustion chamber deposits and longer spark plug life. Leaded gasoline may be used if lead-free is not available.

**NOTE: NEVER USE METHANOL, GASOLINE CONTAINING METHANOL, GASOHOL CONTAINING MORE THAN 10% ETHANOL, PREMIUM GASOLINE OR WHITE GAS BECAUSE ENGINE FUEL SYSTEM COULD BE DAMAGED.**

**C** Clean around fuel cap before removing. Fill fuel tank with gasoline/oil mix to within 1/4 inch (6.5 mm) of top of tank, not into filler neck. **DO NOT OVER-FILL TANK.** Replace fuel cap securely and wipe up any spilled fuel.

**D** Lawn-Boy recommends that Lawn-Boy 2+4® Fuel Conditioner be used regularly during operation and storage. Lawn-Boy 2+4® Fuel Conditioner cleans the engine during operation and prevents gum-like varnish deposits from forming in the engine during storage.

**DO NOT USE FUEL ADDITIVES OTHER THAN THOSE MANUFACTURED FOR FUEL STABILIZATION DURING STORAGE, SUCH AS LAWN-BOY 2+4® FUEL CONDITIONER. LAWN-BOY DOES NOT RECOMMEND STABILIZERS WITH AN ALCOHOL BASE SUCH AS ETHANOL OR METHANOL. STABILIZERS SHOULD NOT BE USED TO TRY TO ENHANCE THE POWER OR PERFORMANCE OF MACHINE.**

**E** Connect spark plug wire (if disconnected).

## **LAWN PREPARATION AND MOWING**

Review **SAFETY INSTRUCTIONS** and read this manual carefully before operating mower.

Clear area of sticks, stones, wire, branches and other debris which could be picked up or hit by cutting blade and become thrown objects.

Keep everyone, especially children and pets, away from area of operation.

Avoid striking trees, walls, curbs or other solid objects. Never deliberately mow over any object.

If an object is struck, or mower starts to vibrate, immediately stop engine, disconnect spark plug wire and examine mower for damage.

Replace blade when necessary with an original equipment replacement blade for best results.

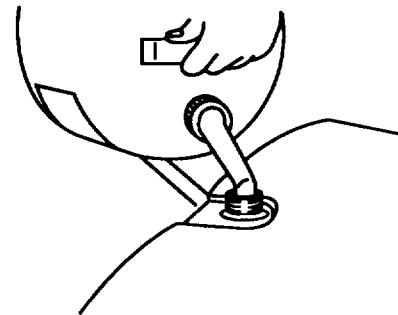

**Fig. C**



**Fig. D**

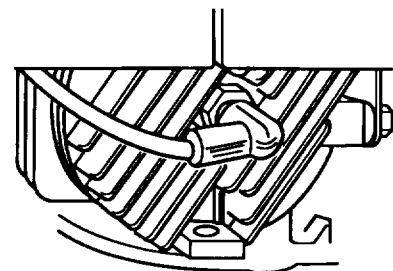

**Fig. E**

# 3 OPERATION

## STARTING ENGINE

**NOTE:** Follow steps in Section 2 BEFORE STARTING.

**A** Open fuel shut-off valve.

**B** Move throttle lever to START  position.

**NOTE:** A warm engine generally will not require choking.

**C** Hold blade control bail against upper handle.

Pull starter handle lightly until resistance is felt, then pull sharply. Let rope return to handle slowly.

When engine starts, move throttle to FAST  position.

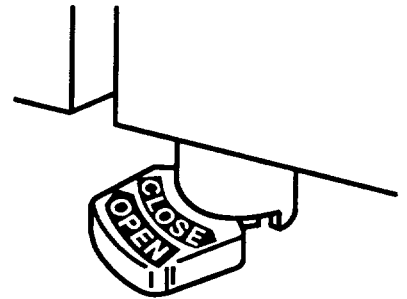

Fig. A

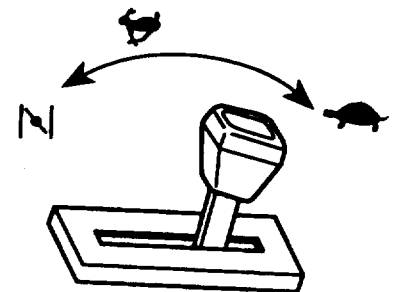

Fig. B

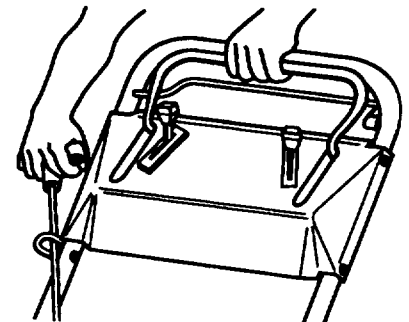



Fig. C

## STOPPING ENGINE

**B** Move throttle lever to SLOW  position.

**D** Release blade control bail. Both the engine and blade will stop. See your dealer immediately if they do not.

### TO RESTART ENGINE

Repeat STARTING ENGINE procedure with throttle lever in FAST  position.

If engine fails to start after three (3) pulls, repeat steps **B** and **C**.

**NOTE:** Do not use START  position to restart a warm engine after a short shutdown.

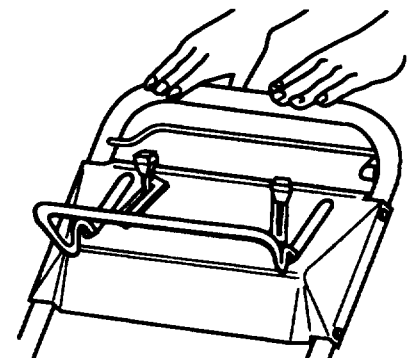

Fig. D



## OPERATION Continued

### ADJUSTING CUTTING HEIGHT

Each wheel is adjusted individually with a wheel height adjustment lever. Cutting heights are 1", 1-1/2", 2", 2-1/2", 3 and 3-1/2 inches (25, 38, 51, 64, 74 and 86 mm).

#### **⚠ DANGER**

- Contact with rotating blade can cause serious injury.
- Stop engine and wait for all movement to stop before adjusting cutting height.
- Do not put fingers under housing when adjusting height of cut.

**E** To change cutting height pull adjusting lever toward wheel and move to the desired position.

Release height adjust lever and seat securely in notch.

**NOTE:** Set all four (4) wheels at the same height.



Fig. E

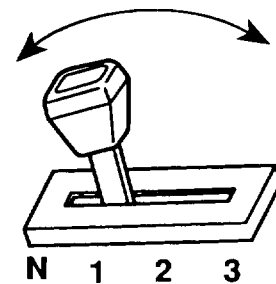

Fig. F

### SELF-PROPELLED DRIVE

(self-propelled models only)

**F** Move ground speed lever to one (1) of three (3) ground speeds, 1 - slow, 2 - medium or 3 - fast. Select a speed that is comfortable to walk and not too fast for grass length.

**NOTE:** Do not change ground speeds with self-propelled drive engaged. Stop mower, place ground speed lever in desired position, then continue mowing.

Move ground speed lever to **N** - neutral when trimming or leaving mower.

**G** To operate self-propelled drive squeeze self-propelled bail against handle and hold.

**NOTE:** Slight variations in ground speed can be made by increasing space between self-propelled bail and handle.

**H** To disengage self-propelled drive, release self-propelled bail.

**NOTE:** Mower is equipped with free-wheeling clutches for low pullback effort. To disengage clutches mower may need to be pushed forward 1 inch after self-propelled bail has been released.

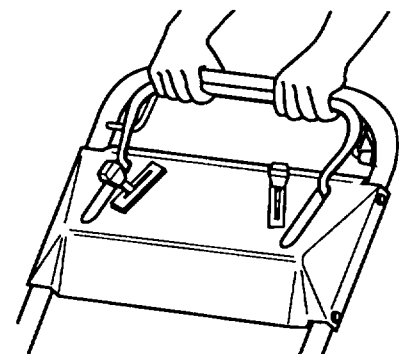

Fig. G

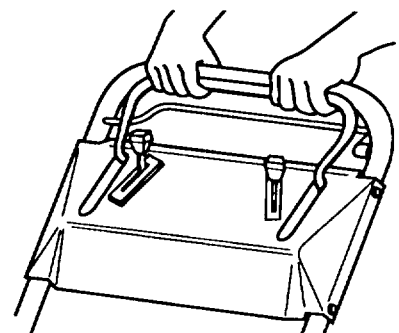

Fig. H

# 4 MAINTENANCE

Continued safe and dependable operation requires routine maintenance.

## **▲ DANGER**

- **Accidental starting of engine can cause serious injury.**
- **Stop engine and disconnect spark plug wire before cleaning underside of housing, clogged grass discharge chute or performing maintenance.**

## RECOMMENDED MAINTENANCE SCHEDULE

5 Hours	Fasteners	Check blade and engine mounting fasteners frequently. Keep all nuts, bolts and screws tight to ensure safe operation.
25 Hours	Air Filter	Remove and clean each mowing season or every 25 hours. More frequently if operating conditions are dusty.
	Spark Plug	Clean, inspect and gap. Replace if necessary.
	Housing	Clean built-up grass clippings and dirt.
50 Hours	Blade	Sharpen or replace; maintain more frequently if edge is dulled quickly in rough or sandy conditions.
	Blade Brake	Check stopping time every 50 hours or at start of each mowing season. Blade must stop within 3 seconds of releasing bail; if not see your Authorized Lawn-Boy Service Dealer for repair.
	Lubrication	Grease rear height adjustor brackets (self-propelled models).
	Exhaust Ports	Clean every 50 hours or at least once each mowing season.
	Fuel System	Check for leakage and/or deterioration of fuel hose. Replace if necessary.
100 Hours	Cooling System	Clean grass clippings, debris or dirt that clog engine air cooling fins and starter. More frequently under dirty or high chaff conditions.

## AIR FILTER

Once every season or every 25 hours clean air filter; more frequently under dusty conditions.

**NOTE:** Do not operate engine without air filter element; extreme engine wear or damage will occur.

**A** To remove air filter, snap cover latch open, swing to side and unhook.

Remove cover and air filter.

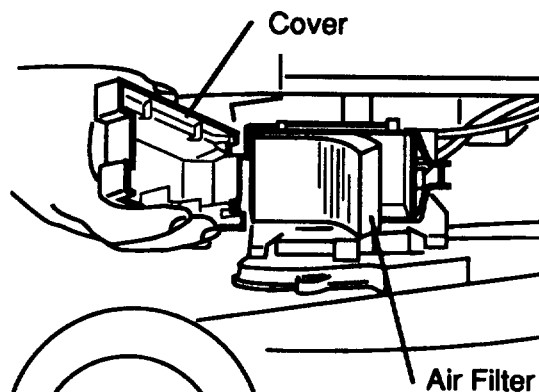

**Fig. A**

## MAINTENANCE Continued

**B** Wash air filter in laundry detergent or kerosene.

Squeeze to remove excess liquid and blot dry with a paper towel or rag.

**C** Apply one tablespoon of SAE 30W oil to the air filter.

Squeeze until oil is distributed evenly throughout filter. Blot lightly with paper towel to remove excess oil.

Replace filter with cleaner side facing carburetor.

**NOTE:** Be sure filter is fully seated in air box and does not pucker allowing direct passage of air and dirt.



**Fig. B**

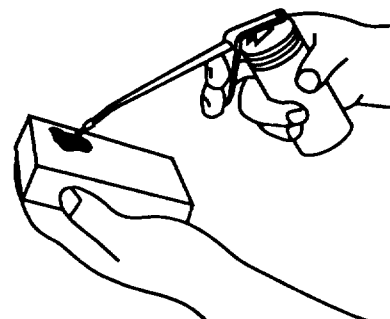

**Fig. C**

## SPARK PLUG

A spark plug that is dirty, pitted, carbon covered or has worn electrodes may cause hard starting and poor operation.

Clean or replace spark plug once a season or every 25 hours, whichever occurs first. Use Champion RJ12C, or equivalent.

Remove spark plug and clean with a wire brush, removing carbon build-up. **DO NOT SAND BLAST.** Check condition of plug for cracks, damaged or worn electrodes. Replace if necessary.

**D** Set spark plug gap at .035 inch (.85 mm).

Install spark plug by hand, then torque to 180 in.-lbs. (15 ft.-lbs.) (20 Nm).

**E** Connect spark plug wire when maintenance is completed.

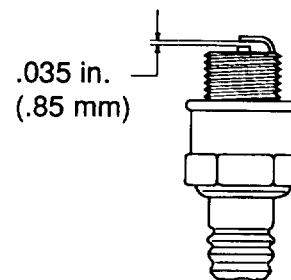

**Fig. D**

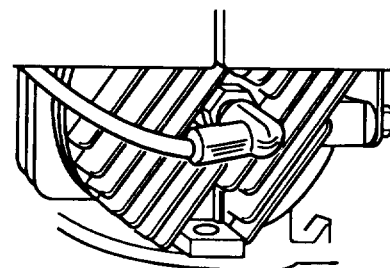

**Fig. E**

## MAINTENANCE Continued

### CLEAN MOWER HOUSING

A clean mower housing provides the best cutting performance. Check for grass build-up and clean after each use.

Disconnect spark plug wire.

**F** Tip mower onto right side.

#### **⚠ WARNING**

- Gasoline is extremely flammable, highly explosive and under certain conditions can cause personal injury or property damage.
- Tipping mower may cause fuel leakage from carburetor or fuel tank.
- Avoid fuel spills by running engine dry or remove gas with hand pump, never siphon.

Scrape built-up grass clippings and dirt from mower housing with a hardwood scraper.

**NOTE:** Do not use metal scraper or screwdriver which may cause scratches or nicks.

Connect spark plug wire when maintenance is completed.

### BLADE

A straight, sharp blade provides maximum cutting performance. Regularly inspect and sharpen blade.

#### **⚠ WARNING**

- Blade is sharp and can cause serious injury.
- Wear gloves or wrap sharp edges of the blade with a rag.

#### **BLADE STRAIGHTNESS**

Disconnect spark plug wire.

**G** Measure the distance from the bottom edge of the mower housing to the blade tip. Rotate the blade 180° and measure to other blade tip.

If measurements are not within 1/8 inch (3.2 mm), blade should be replaced. If, after blade replacement, the measurements are still not within 1/8 inch (3.2 mm), the crankshaft should be checked for straightness by your Authorized Lawn-Boy Service Dealer.

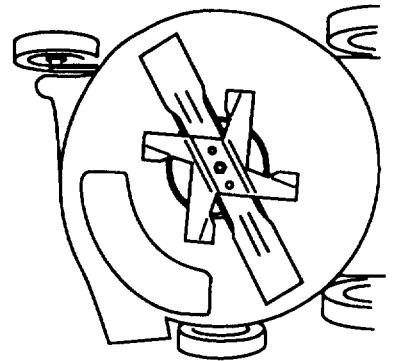

Fig. F

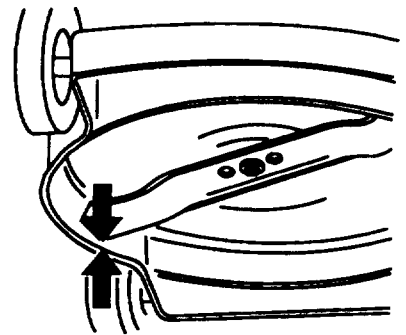

Fig. G

# MAINTENANCE Continued

## BLADE REMOVAL

**H** Remove blade nut and mulching fan.

Remove blade from blade driver.

Examine blade cutting edges for nicks, cutting angle and sharpness. Sharpen or replace if necessary.

Examine mulch fan for worn or bent blades. Replace if necessary.

Examine blade driver for bent or sheared drive lugs. Replace if necessary.

## BLADE SHARPENING

### **⚠ WARNING**

- Thrown objects can cause serious eye injury.
- Wear proper eye protection when sharpening blade.

**I** Sharpen only the leading edge of blade with a file or grinder. Do not sharpen beyond the recommended area.  
**NOTE:** Blade should not be ground more than 5 inches (127 mm) from outside ends and no less than 2 inches (51 mm) from trailing edge.

## BLADE BALANCING

**J** Check the balance of blade by placing the center hole of blade over a nail or screwdriver shank clamped horizontally in a vise.

If either end of blade rotates downward, grind or file that end (not the cutting edge). Blade is properly balanced when neither end drops.

## BLADE INSTALLATION

**H** Install blade driver onto crankshaft (if removed).

Locate blade over lugs of blade driver with curved ends toward mower housing.

**K** Install mulch fan into blade recess and secure with blade nut.

Torque blade nut to 560 in.-lbs. (47 ft.-lbs.) (63 Nm).

**NOTE:** Blade nut must be replaced after installing and removing four (4) times. Locking feature will decrease and nut could loosen if not replaced.

Connect spark plug wire when maintenance is completed.

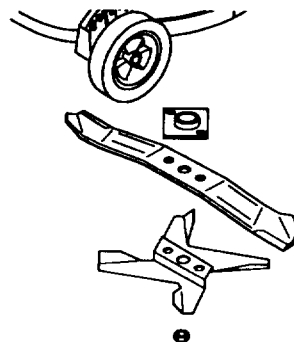

Fig. H

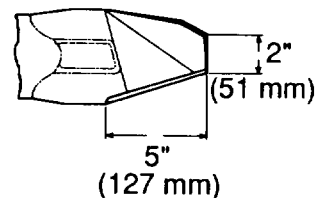

Fig. I

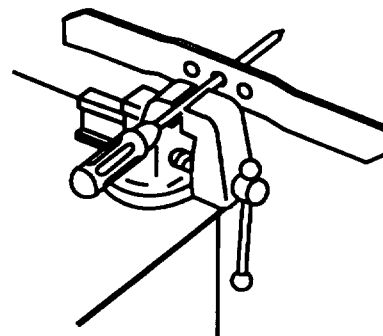

Fig. J

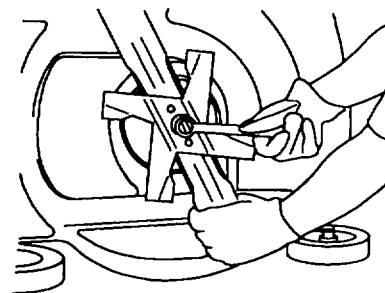

Fig. K

# MAINTENANCE Continued

## LUBRICATION

### REAR HEIGHT ADJUSTORS (self-propelled models only)

**L** Wipe grease fittings with clean rag. Install grease gun onto fitting and gently apply 1 or 2 pumps of #2 multi-purpose lithium grease. Excess grease may damage seals and prevent proper wheel clutch operation.

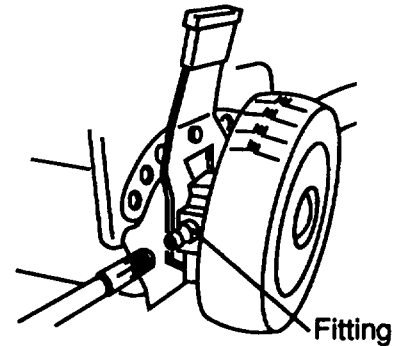

Fig. L

## SELF-PROPELLED CABLE

(self-propelled models only)

Whenever handle height is changed, a new self-propelled cable is installed or traction drive belt slips, adjustment is required.

Self-propelled cable is adjusted at the left handle bracket by moving cable jacket held by jam nuts.

**M** Hold self-propelled bail 1 to 1-1/2 in. (25 to 38 mm) from handle. Adjust jam nuts, at handle bracket, so cable is tight, but spring is not stretched.

Tighten jam nuts securely.

Release bail and check to see that cable is loose.

**NOTE:** Cable must be loose with bail in released position or mower may creep when bail is disengaged.

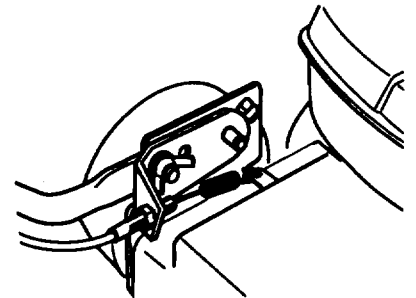

Fig. M

# MAINTENANCE Continued

## EXHAUST PORTS

Carbon deposit build-up causes excessive wear and loss of power. Check and clean if necessary.

Remove spark plug and tip mower on its side. See SPARK PLUG.

Remove blade nut, mulch fan and blade. See BLADE REMOVAL.

**N** Remove blade driver by tapping with plastic or fiber hammer in the direction of rotation. This will loosen the blade driver from taper on crankshaft.

**O** Remove bolts attaching muffler and crankshaft support.

**P** Rotate crankshaft slowly until piston covers exhaust ports.

Using a 3/8 inch wooden dowel loosen carbon deposits by inserting dowel into ports.

**NOTE:** Do not use metal tools; these could scratch piston.

**Q** Set mower upright. Holding blade control bail against handle pull starter rope several times to blow out loose carbon.

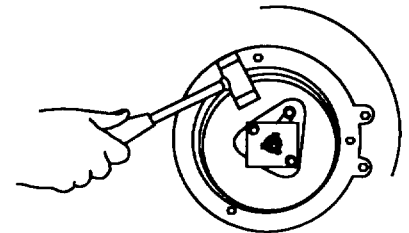

Fig. N

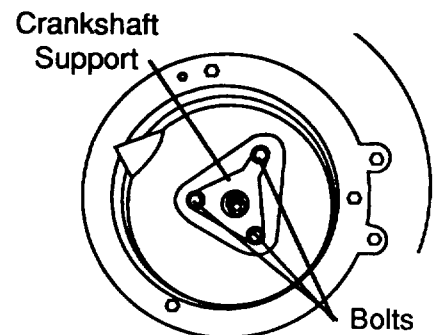

Fig. O

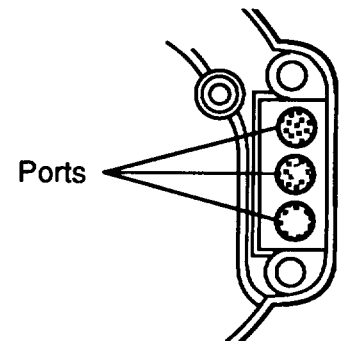

Fig. P

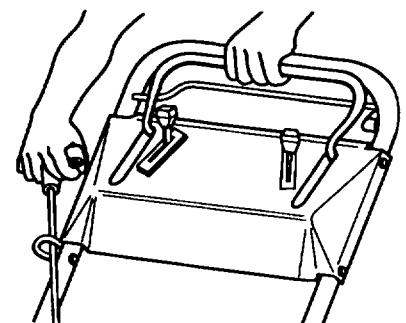

Fig. Q

## **MAINTENANCE** Continued

**R** Clean carbon deposits from muffler and tube with wire brush and wood dowel. Wipe muffler clean with paper towel or rag.

**S** Install muffler and crankshaft support to engine mounting plate.

**NOTE:** Crankshaft support must have equal clearance around crankshaft circumference to prevent contact with crankshaft.

Torque muffler bolts to 155 in.-lbs. (13 ft.-lbs.) (18 Nm).

Attach blade driver, blade and mulch fan with blade nut. See **BLADE INSTALLATION**.

Torque blade nut to 560 in.-lbs. (47 ft.-lbs.) (63 Nm).

**NOTE:** Blade nut must be replaced after installing and removing four (4) times. Locking feature will decrease and nut could loosen if not replaced.

Connect spark plug wire when maintenance is completed.

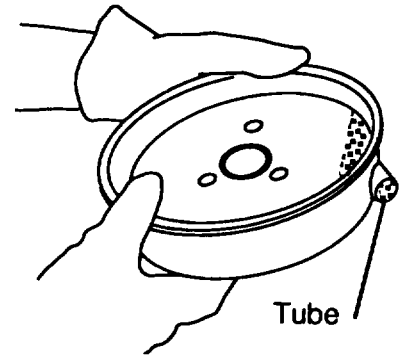

**Fig. R**

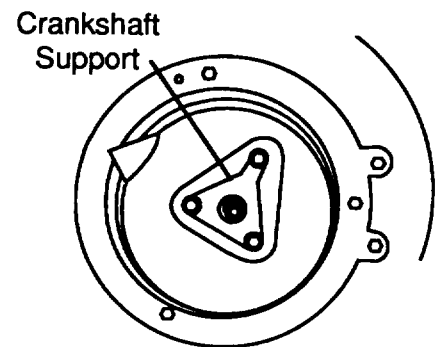

**Fig. S**



# 5 TROUBLESHOOTING

---

Your mower was designed and built for trouble-free operation. Check the following components and items carefully. If a problem continues, see your Authorized Lawn-Boy Service Dealer.

## Problem: **ENGINE WILL NOT START:**

### Solution:

- Fill fuel tank with fresh gasoline/oil mix
- Move throttle lever to the START  position
- Spark plug
  - Connect spark plug wire
  - Clean spark plug, check spark plug gap, replace if damaged



## Problem: **ENGINE STARTS HARD OR LOSES POWER:**

### Solution:

- Drain and refill fuel tank with fresh gasoline/oil mix
- Clean gas cap vent hole
- Clean or replace air filter element
- Clean mower discharge chute
- Clean underside of mower deck
- Clean spark plug, check spark plug gap, replace if damaged

## Problem: **ENGINE RUNS ROUGH:**

### Solution:

- Connect spark plug wire
- Clean spark plug, check spark plug gap, replace if damaged
- Move throttle lever from SLOW  to FAST  position
- Clean or replace air filter element

## Problem: **MOWER OR ENGINE VIBRATES EXCESSIVELY:**

### Solution:

- Balance blade
- Tighten blade mounting nut
- Clean mower discharge chute
- Clean underside of mower deck
- Tighten engine mounting bolts



## Problem: **UNEVEN CUTTING PATTERN:**

### Solution:

- Place all four (4) wheels at same height
- Sharpen and balance blade
- Change mowing pattern
- Clean underside of mower deck

## Problem: **DISCHARGE CHUTE PLUGS:**

### Solution:

- Move throttle lever from SLOW  to FAST  position
- Raise cutting height
- Allow grass to dry before mowing
- Clean underside of mower deck

## Problem: **WILL NOT SELF-PROPEL**

### Solution:

- Adjust self-propelled cable

# 6 ACCESSORIES

Optional accessories may have been shipped with your mower or are available from your Authorized Lawn-Boy Dealer. For proper installation follow these instructions.

## REAR GRASS CATCHER

### **▲ WARNING**

- Thrown objects or blade contact can cause serious injury.
- Never operate mower unless cover plate, mulch plate or grass chute and catcher are installed.

Stop engine and disconnect spark plug wire before installing or removing grass chute.

- A** Insert chute support rod through hole at right rear of deck.
- B** Place chute assembly into housing opening.

Two shoulder bolts on the mower housing protrude through slotted holes in the chute assembly and do not have to be loosened or removed. Chute assembly moves over the shoulder bolts.

Slide chute assembly in a clockwise direction to install or counter-clockwise to remove.

Secure with wing screw.

- C** Remove knob and bolt securing left side upper and lower handle sections.

Hold hanger clamp on outside of handle sections. Insert handle bolt from inside of handle sections through holes in hanger clamp.

Position bag hanger leg into hanger clamp groove and secure with knob. Repeat steps and assemble clamp and hanger to right side handle sections.

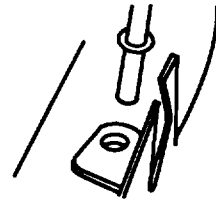

Fig. A

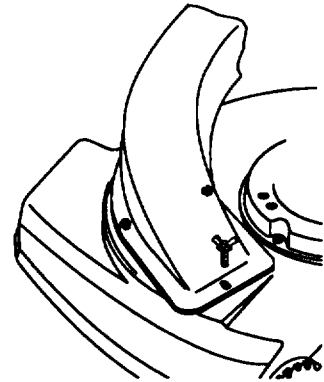

Fig. B

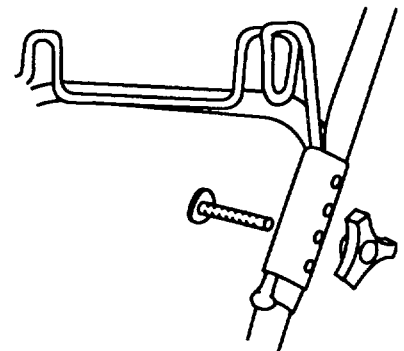

Fig. C

## ACCESSORIES *Continued*

**D** Close rear of bag by folding sides in and pressing interlocking rear handle halves together.

Position rear bag handles into bag hanger on handle.

**E** Grasp bag assembly handle and slide over flange of grass chute. Push downward on handle until it seats into position.

### BAG ADJUSTMENT

When handle height is changed bag adjustment may be required. A properly adjusted bag should be taut on top cloth area between front bag handle and rear bag hanger handles. If bag is too tight or too loose, adjust as follows:

**F** Remove bag from rear bag hanger. Remove bolt(s) and knob(s) securing hanger clamps to handle sections. Hanger clamps have four adjustment holes.

Reassemble hanger clamps to handle sections using whichever set of holes best holds bag taut. Using lower holes in hanger clamps tightens bag assembly and upper holes in hanger clamps loosens bag assembly.

### **⚠ WARNING**

- Thrown objects or blade contact can cause serious injury.
- Keep hands, sticks or other objects out of grass chute while blade is turning.
- Always stop engine when emptying grass bag and disconnect spark plug wire before cleaning a clogged chute, bag tunnel or underside of mower housing.

**NOTE:** Under normal use, bag materials are subject to deterioration and wear. Check grass bag often and replace when necessary with an original equipment replacement bag. A weakened or inferior bag may let objects pass through, causing injury.

Connect spark plug wire.

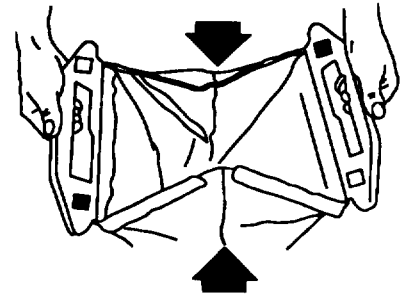

Fig. D

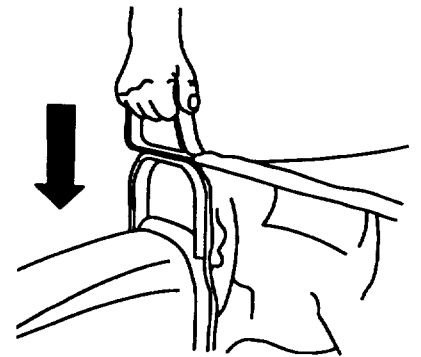

Fig. E

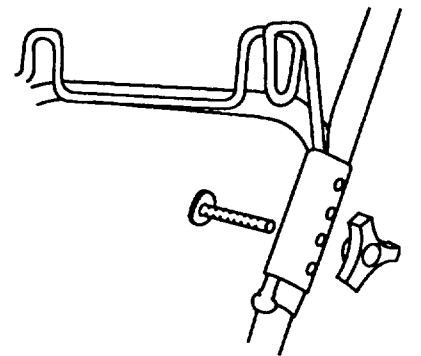

Fig. F

## ACCESSORIES Continued

### POWER MULCH™ PLATE

#### **⚠ WARNING**

- Thrown objects or blade contact can cause serious injury.
- Never operate mower unless cover plate, mulch plate or grass chute and catcher are installed.

Stop engine and disconnect spark plug wire before installing or removing mulch plate.

**G** Insert mulch plate into housing opening.

**H** Two shoulder bolts on the housing protrude through slotted holes in the mulch plate and do not have to be loosened or removed. Mulch plate moves over the shoulder bolt heads.

Slide mulch plate clockwise to install or counter-clockwise to remove.

Secure with wing screw.

Connect spark plug wire.

**NOTE:** Use only Lawn-Boy original equipment or Lawn-Boy replacement cutting blade. Other blades may strike mulch plate when engine is started and run.

#### **MULCHING OPERATION**

Set engine speed control to MULCH ZONE.  Full RPM provides the best possible mulching of grass and leaves.

*To achieve the best mulching action set mower height of cut so no more than 1/3 of grass stem is cut off; maximum of 1-1/2 inch (38 mm) long clippings. If you attempt to mulch more or if grass is very lush, mulching action will be poor. Under these conditions it may be beneficial to use side discharge or catch grass clippings instead of mulching. A few days later a pass with the mulch plate installed will put you back on schedule.*

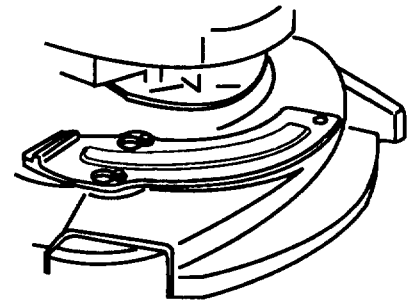

Fig. G

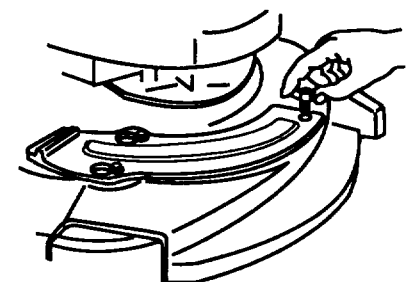

Fig. H

# 7 STORAGE

To prepare lawn mower for off-season storage perform recommended maintenance procedures. See Section 4 MAINTENANCE.

Store mower in a cool dry place.

## FUEL

### ⚠ WARNING

- Do not store gasoline (fuel) unnecessarily over long periods of time.
- To prevent possible explosion, store fuel in approved container.
- To prevent possible explosion of vaporized fuel, do not store mower with fuel in the tank or carburetor in an enclosure with an open flame. (Example: furnace or water heater pilot light.)
- Allow the engine to cool before storing in any enclosure.

**A** We recommend Lawn-Boy 2 + 4® Fuel Conditioner to stabilize fuel for storage. If possible, the last fuel fill of the year should be treated with Lawn-Boy 2 + 4® Fuel Conditioner.



Fig. A

Plan ahead and try to run the fuel tank empty when mowing the last time prior to storage. The smaller the amount of fuel in the tank, the shorter the time required to run the fuel system dry. Run mower until engine stops from lack of fuel.

## ENGINE

**B** Remove spark plug. Using an oil can, squirt about one tablespoon of oil through spark plug hole.

**C** Slowly rotate engine several times, using starter rope, to distribute oil.

Replace spark plug but DO NOT connect spark plug wire.

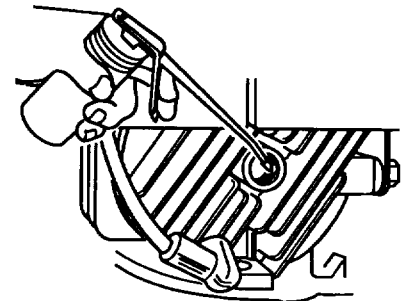

Fig. B

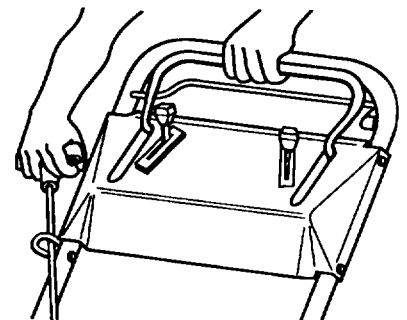

Fig. C

## STORAGE Continued

### FOLDING HANDLE

**D** Remove handle mounting hardware from handle brackets.

**NOTE:** Save handle mounting hardware, replace in handle bracket holes.

**E** Rotate handle toward front of mower.

**NOTE:** Fold handle only as illustrated. If handle is folded in opposite direction damage will occur to control cables.

Loosen knobs securing top handle section to bottom section and fold top handle section back toward rear of mower into storage position.

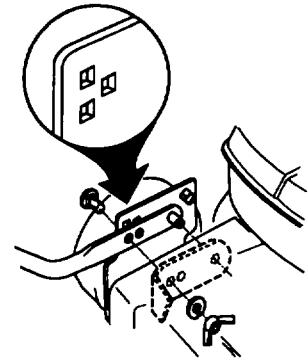

**Fig. D**

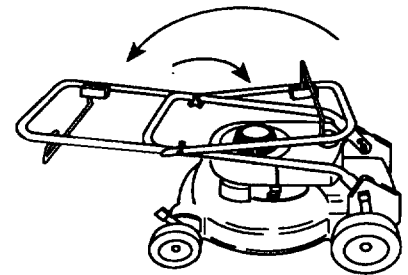

**Fig. E**

### REMOVING FROM STORAGE

Unfold handle. See Section 1 ASSEMBLY-Handle.

Check and tighten all fasteners.

Remove spark plug and spin engine rapidly using starter to blow excess oil from the cylinder. Clean spark plug or replace if cracked, broken or electrodes are worn.

Install spark plug, torque to 180 in.-lbs. (15 ft.-lbs.) (20 Nm).

Perform recommended maintenance procedures. See Section 4 MAINTENANCE.

**F** Fill fuel tank with fresh, clean gasoline/oil mix.

**G** Connect spark plug wire.

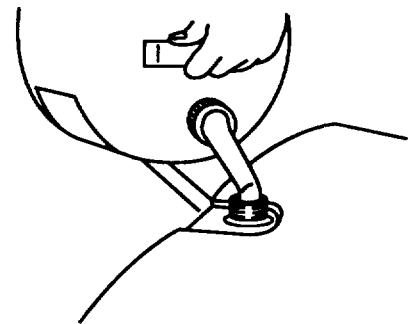

**Fig. F**

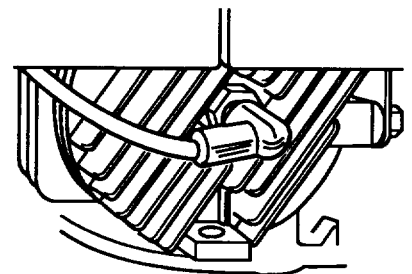

**Fig. G**



# A LIMITED WARRANTY

## What Is Covered By This Express Warranty?

Lawn-Boy Inc. promises to repair any Lawn-Boy walk mower or riding product for the following time periods if defective in materials or workmanship. The cost of parts and labor are included, but the customer pays transportation costs. The following time periods apply for residential use:

### Walk Power Mowers:

- |  |          |
|--|----------|
| • All components except those listed below                   | 2 years  |
| • Ignition Module  | 5 years  |
| • M Series Mowers (except mower housing and ignition module) | 3 years  |
| • M Series Mower Housing                                     | Lifetime |

Riding Mowers (all components) 2 years

Transportation within a 15 mile radius of the servicing dealer is covered under this warranty for all Lawn-Boy riding products. Walk power mowers and other products not specifically covered are excluded from the transportation coverage provided by this warranty.

## What About Commercial Use?

When used for commercial, rental, or institutional use, the following warranty time periods apply:

C Series Walk Power Mowers	1 year
All Other Walk Power Mowers	45 days
Riding Products	90 days

## How Do You Get Warranty Service?

Should you feel your Lawn-Boy product contains a defect in material or workmanship, contact the dealer who sold you the product or any Authorized Lawn-Boy Service Dealer. The Yellow Pages of your telephone directory is a good reference source. The dealer will either arrange service at his/her dealership or recommend another Authorized Service Dealer who may be more convenient. You may need proof of purchase (copy of registration card, sales receipt, etc.) for warranty validation.

If for any reason you are dissatisfied with the Service Dealer's analysis of the defect in materials or workmanship or if you need a referral to a Lawn-Boy Service Dealer, please feel free to contact us at the following address:

Lawn-Boy Customer Service Department  
8111 Lyndale Avenue South  
Bloomington, MN 55420-1196  
612-888-8801

## What Must You Do To Keep The Warranty In Effect?

You must maintain your Lawn-Boy Product by following the maintenance procedures described in the operator's manual. Such routine maintenance, whether performed by a dealer or by you, is at your expense.

## What Does This Warranty Not Cover? and How Does Your State Law Relate To This Warranty?

There is no other express warranty. This express warranty does not cover:

- Cost of regular maintenance service or parts, such as filters, fuel, lubricants, tune-up parts, blade sharpening, brake and clutch adjustments.
- Any product or part which has been altered or misused or required replacement or repair due to normal wear, accidents, or lack of proper maintenance.
- Repairs necessary due to improper fuel, contaminants in the fuel system, or failure to properly prepare the fuel system prior to any period of non-use over three months.
- Pickup and delivery charges for distances beyond a 15 mile radius from an Authorized Lawn-Boy Service Dealer (covered products only).

All repairs covered by this warranty must be performed by an Authorized Lawn-Boy Service Dealer using Lawn-Boy approved replacement parts. Repair by an Authorized Lawn-Boy Service Dealer is your sole remedy under this warranty.

**All implied warranties of merchantability and fitness for use are limited to the duration of the express warranty.**

**Some states do not allow limitations on how long implied warranty lasts, so the above limitation may not apply to you.**

**Lawn-Boy is not liable for indirect, incidental or consequential damages in connection with the use of the Lawn-Boy Products covered by this warranty, including any cost or expense of providing substitute equipment or service during reasonable periods of malfunction or non-use pending completion of repairs under this warranty. Some states do not allow exclusions of incidental or consequential damages, so the above exclusion may not apply to you.**

**This warranty gives you specific legal rights, and you may also have other rights which vary from state to state.**